

Product: MARCO POLO LTE

Product Order Code:

BM-02029

Rugged High Efficiency Water Chamber Antenna

LTE-4G, CELLULAR (2G, 3G)

- Rugged wideband body mounted antenna
- RoHS 2011/65/EU & RoHS3 (2015/863/EU compliant)
- Request samples for test & evaluation via enquiry@bloomice.com



Technical Data

Dimensions	75mm (Overall Height) x 194mm Diameter (Base)	
Weight	160g (Excluding cable)	
Construction Materials	PC/ABS UL94 V0 UV Stable	
Mounting Arrangement	ABS Base Ground Plane Independent	
Temperature Range	-40°C to +85°C	
Protection Class	IP67 / IK09 (IEC 60529)	
Cellular LTE / 2G / 3G		
Frequency Range	LTE 700 + GSM 900:	700 - 960 MHz
	GSM 1800:	1710 - 1880 MHz
	UMTS:	1920 - 2170 MHz
	LTE (High):	2300 - 2655MHz
Impedance	50 Ohm	
Polarisation	Linear	
Radiation Pattern	Omni-Directional	
Max Power @ 30°C	LTE 700 & GSM 900:	35 Watts @ 790-960 MHz
	GSM 1800:	35 Watts @ 1710-1880 MHz
	UMTS:	35 Watts @ 1920-2170 MHz
	LTE (High):	35 Watts @ 2300-2700 MHz
Return loss (VSWR)	≤ 2:1 (All Bands)	
Cable types Available	LL100 50 Ohm Low Loss	
Cable Length	According to customer specification	
Connector	According to customer specification	
Test & Measurement Conditions	300mm x 300mm Ground Plane / 500mm LL100 Cable	

dBi: Referenced to an isotropic radiator

Product: MARCO POLO LTE

Product Order Code:

BM-02029

Typical VSWR Data (LTE)

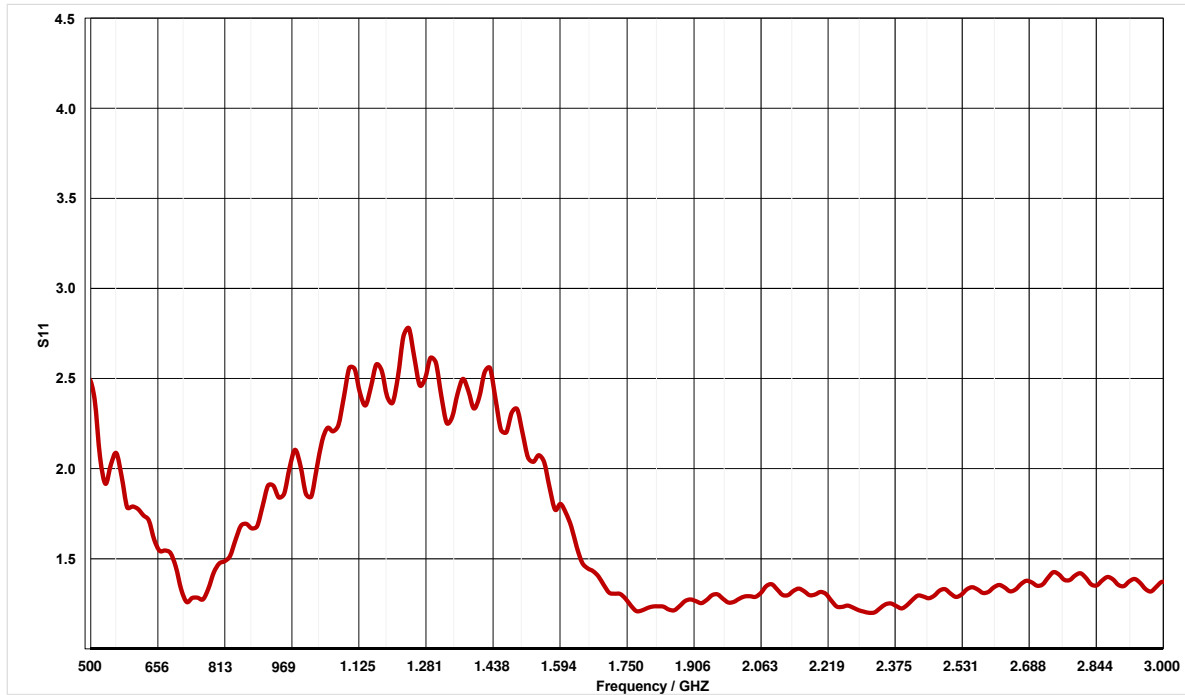

Radiated Efficiency (LTE)

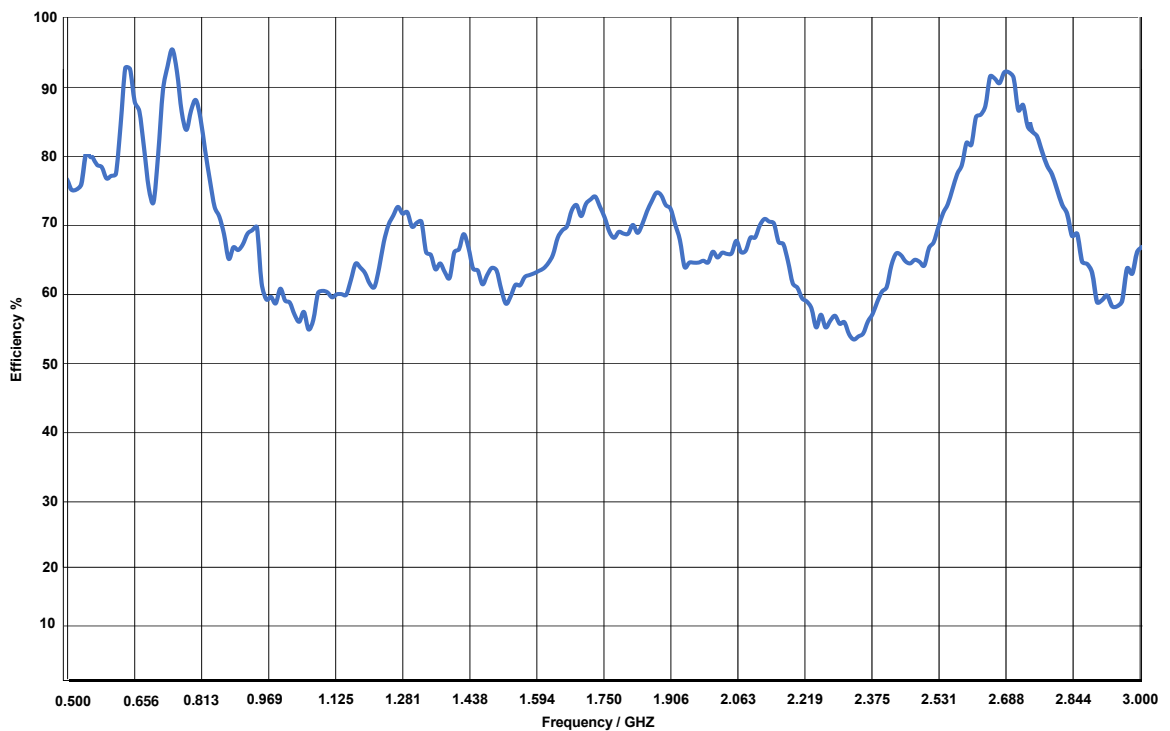

Radiation Patterns

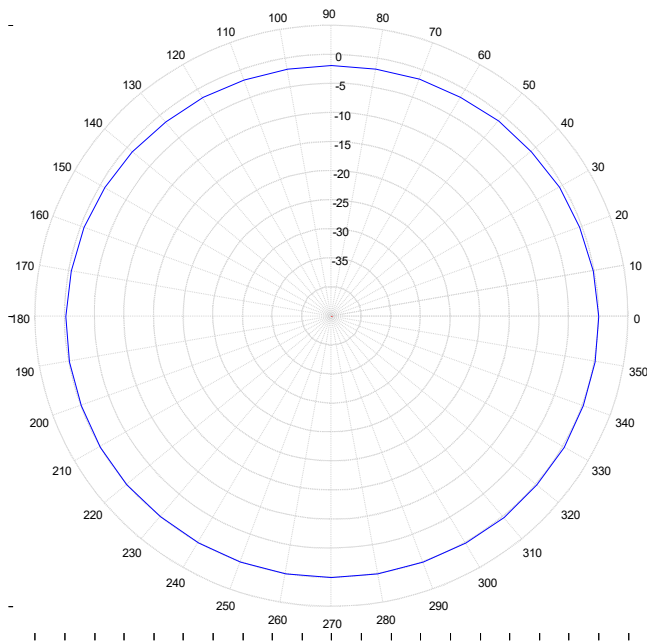

Name: .
Date/Time = 19/10/2023 11:56:59
Plot Scale: 5 dB/Div
Beamwidth: 360 Degrees

Frequency: 693 MHz
MAX dB= 0.1571 @ 330 Deg.
MIN dB= -1.876 @ 90 Deg.
dB Min/Max Delta = 2.0339 dB

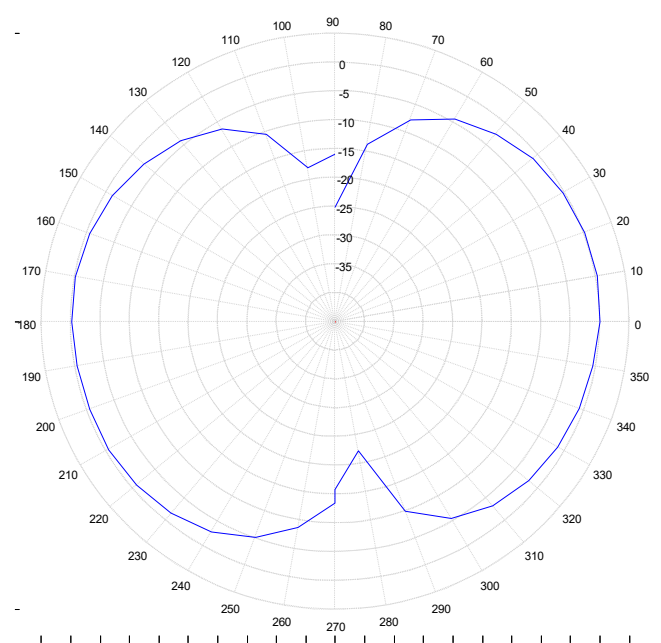

Name: .
Date/Time = 19/10/2023 11:57:57
Plot Scale: 5 dB/Div
Beamwidth: 96.48 Degrees

Frequency: 693 MHz
MAX dB= 0.2277 @ 10 Deg.
MIN dB= -25.22 @ 90 Deg.
dB Min/Max Delta = 25.450 dB

AZIMUTH @ 0°ELEVATION AND ELEVATION @ 0° AZIMUTH - 690MHZ

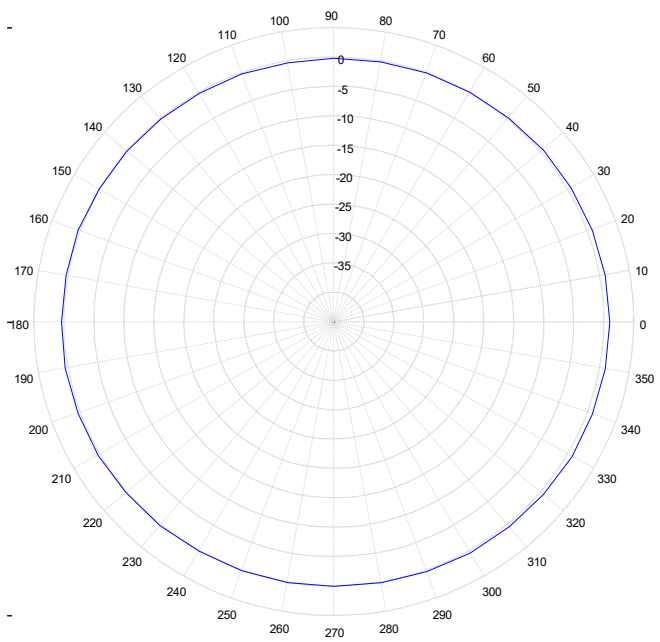

Name: .
Date/Time = 19/10/2023 11:59:18
Plot Scale: 5 dB/Div
Beamwidth: 360 Degrees

Frequency: 800.5 MHz
MAX dB= 0.8869 @ 0 Deg.
MIN dB= -0.232 @ 100 Deg.
dB Min/Max Delta = 1.1193 dB

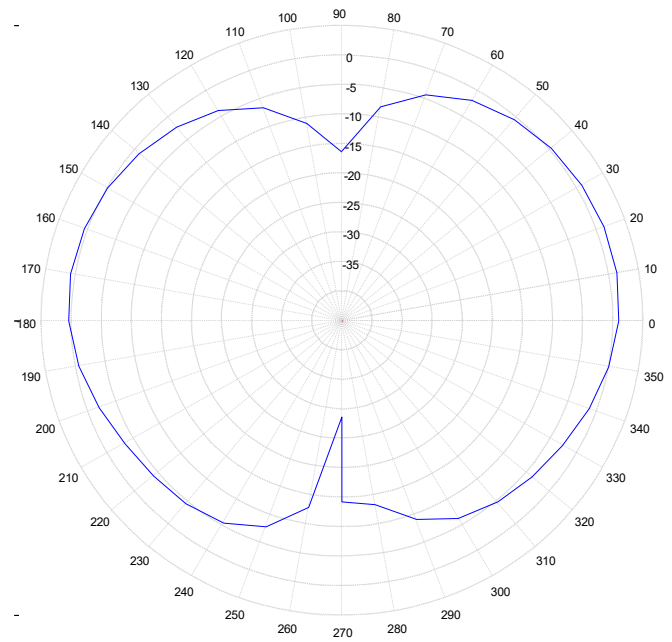

Name: .
Date/Time = 19/10/2023 11:59:54
Plot Scale: 5 dB/Div
Beamwidth: 80.29 Degrees

Frequency: 800.5 MHz
MAX dB= 1.2910 @ 20 Deg.
MIN dB= -28.66 @ -90 Deg.
dB Min/Max Delta = 29.954 dB

AZIMUTH @ 0°ELEVATION AND ELEVATION @ 0° AZIMUTH - 800 MHZ

Radiation Patterns

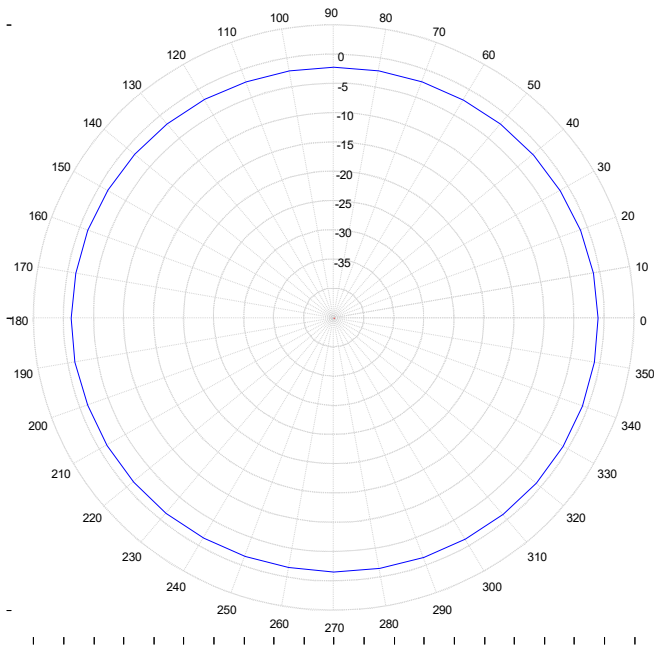

Name: .
 Date/Time = 19/10/2023 12:00:33
 Plot Scale: 5 dB/Div
 Beamwidth: 360 Degrees
 Frequency: 908 MHz
 MAX dB= -1.033 @ 350 Deg.
 MIN dB= -2.221 @ 90 Deg.
 dB Min/Max Delta = 1.1887 dB

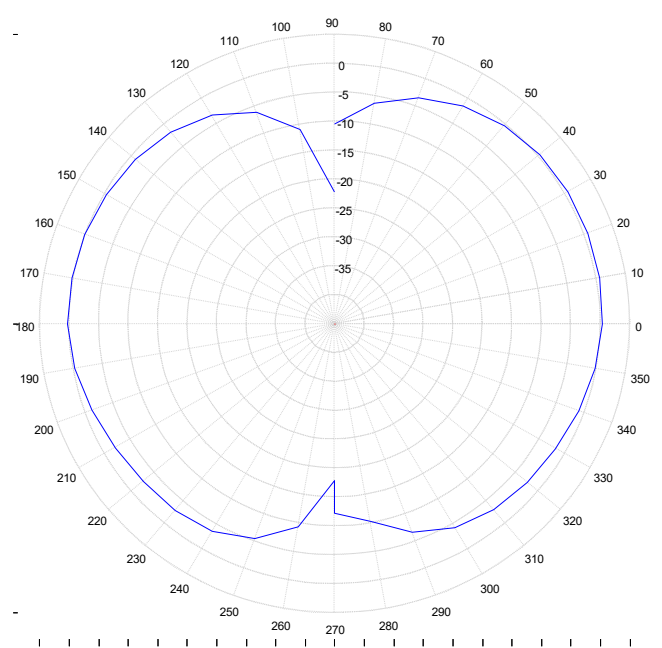

Name: .
 Date/Time = 19/10/2023 12:02:05
 Plot Scale: 5 dB/Div
 Beamwidth: 104.9 Degrees
 Frequency: 908 MHz
 MAX dB= 0.5923 @ 20 Deg.
 MIN dB= -22.19 @ -270 Deg.
 dB Min/Max Delta = 22.787 dB

AZIMUTH @ 0°ELEVATION AND ELEVATION @ 0° AZIMUTH - 900MHZ

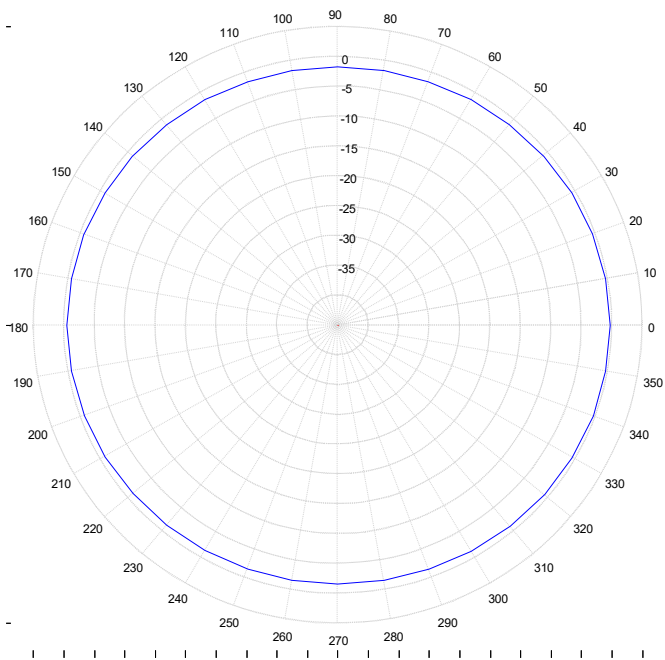

Name: .
 Date/Time = 19/10/2023 12:02:36
 Plot Scale: 5 dB/Div
 Beamwidth: 360 Degrees
 Frequency: 961.75 MHz
 MAX dB= -0.342 @ 350 Deg.
 MIN dB= -1.712 @ 90 Deg.
 dB Min/Max Delta = 1.3697 dB

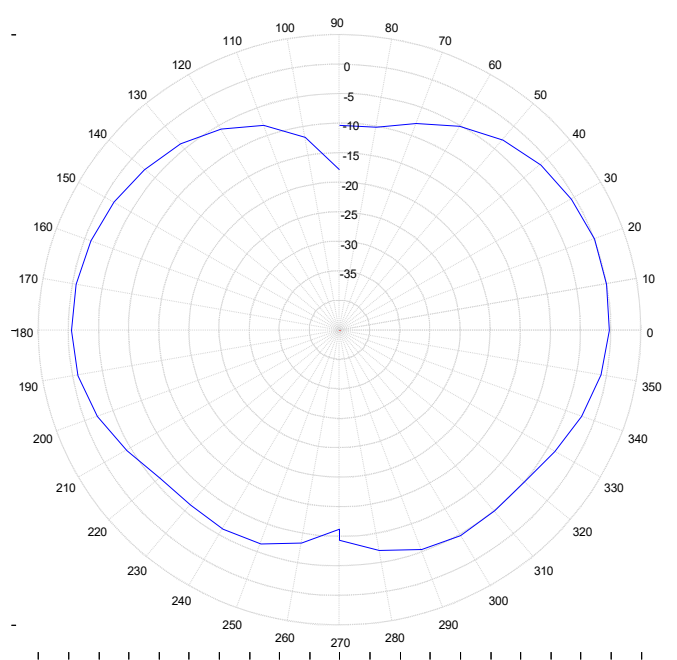

Name: .
 Date/Time = 19/10/2023 12:03:27
 Plot Scale: 5 dB/Div
 Beamwidth: 74.83 Degrees
 Frequency: 961.75 MHz
 MAX dB= -0.044 @ 10 Deg.
 MIN dB= -17.86 @ -270 Deg.
 dB Min/Max Delta = 17.817 dB

AZIMUTH @ 0°ELEVATION AND ELEVATION @ 0° AZIMUTH - 960MHZ

Radiation Patterns

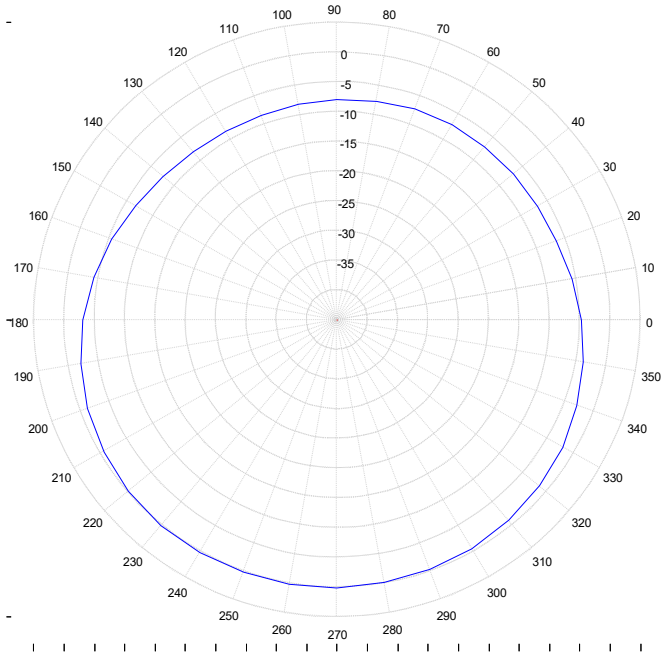

Name: .
Date/Time = 19/10/2023 12:06:03
Plot Scale: 5 dB/Div
Beamwidth: 154.5 Degrees

Frequency: 1703.5 MHz
MAX dB= 0.2250 @ 250 Deg.
MIN dB= -8.432 @ 110 Deg.
dB Min/Max Delta = 8.6573 dB

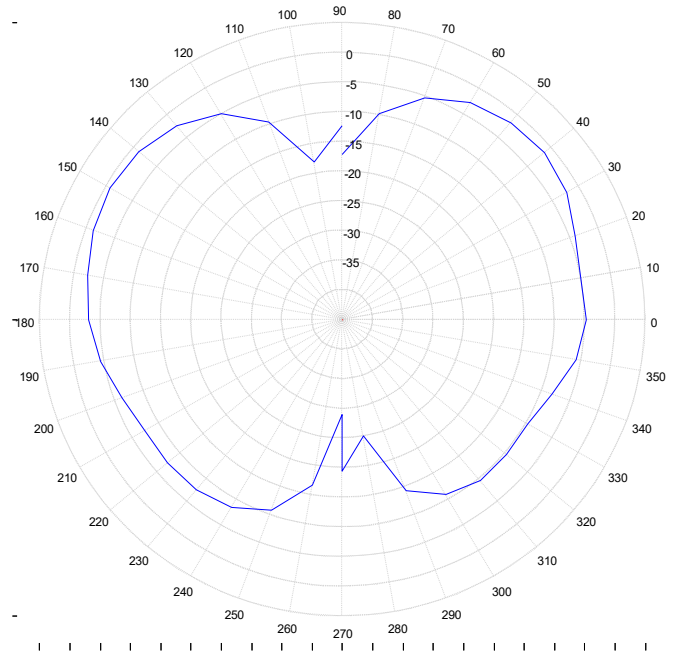

Name: .
Date/Time = 19/10/2023 12:06:53
Plot Scale: 5 dB/Div
Beamwidth: 60.38 Degrees

Frequency: 1703.5 MHz
MAX dB= -0.746 @ -210 Deg.
MIN dB= -29.01 @ -90 Deg.
dB Min/Max Delta = 28.266 dB

AZIMUTH @ 0°ELEVATION AND ELEVATION @ 0° AZIMUTH - 1710MHZ

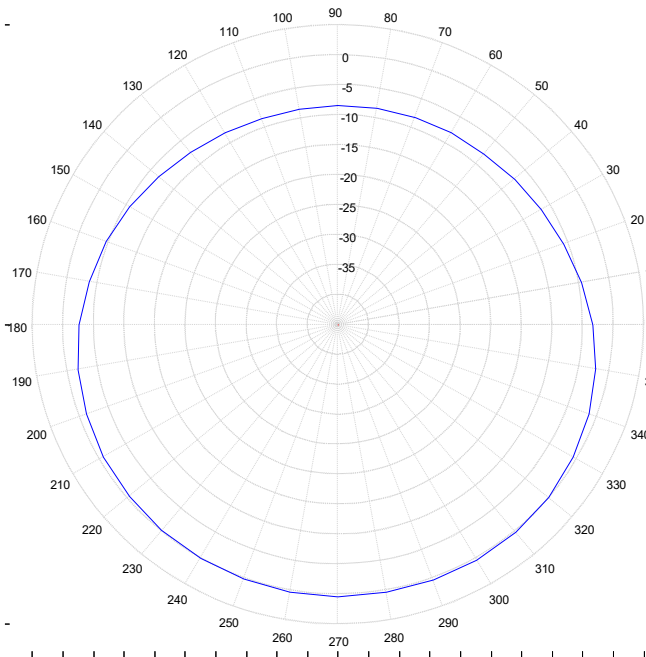

Name: .
Date/Time = 19/10/2023 12:07:50
Plot Scale: 5 dB/Div
Beamwidth: 172.3 Degrees

Frequency: 1800.25 MHz
MAX dB= 0.3784 @ 280 Deg.
MIN dB= -8.470 @ 100 Deg.
dB Min/Max Delta = 8.8488 dB

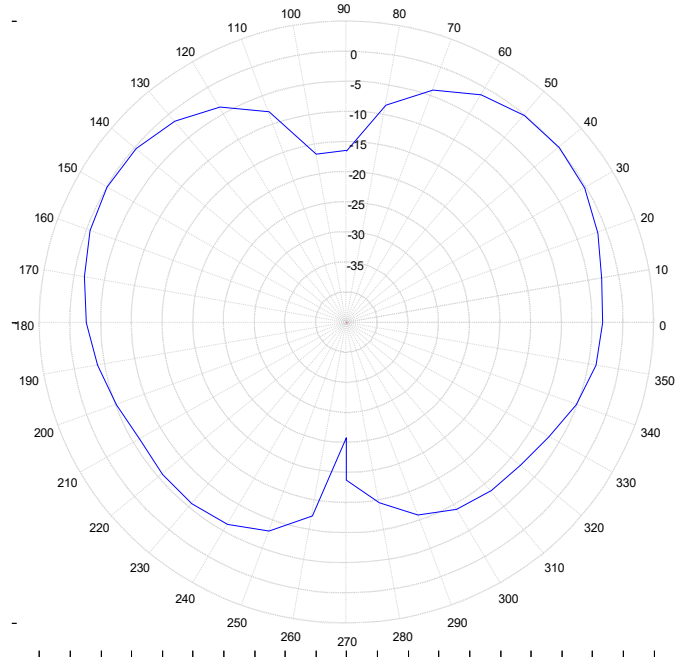

Name: .
Date/Time = 19/10/2023 12:09:20
Plot Scale: 5 dB/Div
Beamwidth: 54.55 Degrees

Frequency: 1800.25 MHz
MAX dB= 0.2148 @ 40 Deg.
MIN dB= -25.87 @ -90 Deg.
dB Min/Max Delta = 26.093 dB

AZIMUTH @ 0°ELEVATION AND ELEVATION @ 0° AZIMUTH - 1800MHZ

Radiation Patterns

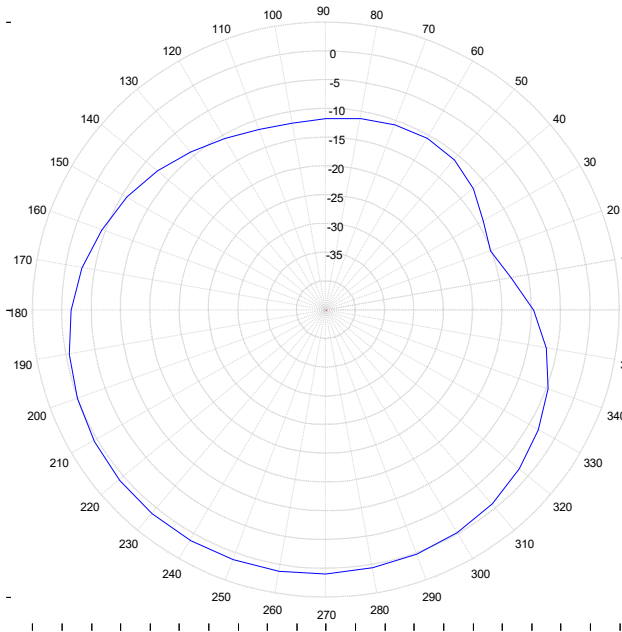

Name: .
Date/Time = 19/10/2023 12:10:21
Plot Scale: 5 dB/Div
Beamwidth: 138.9 Degrees
Frequency: 2176.5 MHz
MAX dB= 1.2378 @ 240 Deg.
MIN dB= -15.21 @ 20 Deg.
dB Min/Max Delta = 16.455 dB

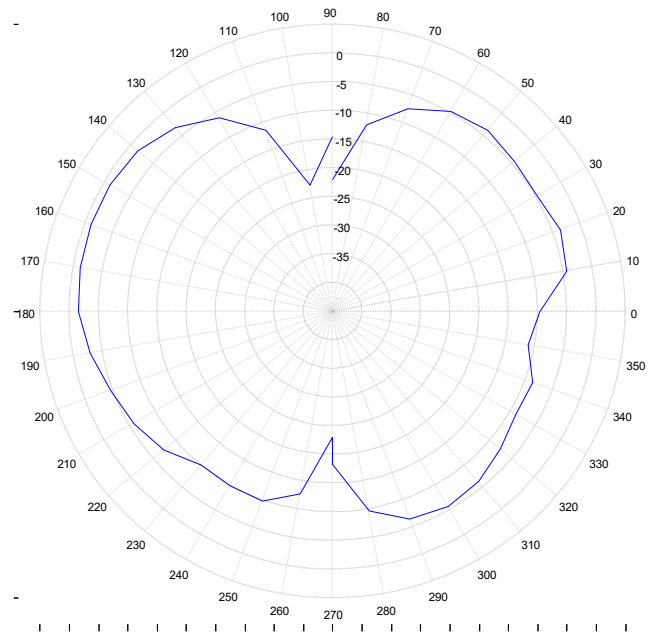

Name: .
Date/Time = 19/10/2023 12:11:59
Plot Scale: 5 dB/Div
Beamwidth: 68.63 Degrees
Frequency: 2176.5 MHz
MAX dB= -0.981 @ -210 Deg.
MIN dB= -22.96 @ -90 Deg.
dB Min/Max Delta = 21.988 dB

AZIMUTH @ 0°ELEVATION AND ELEVATION @ 0° AZIMUTH - 2170MHZ

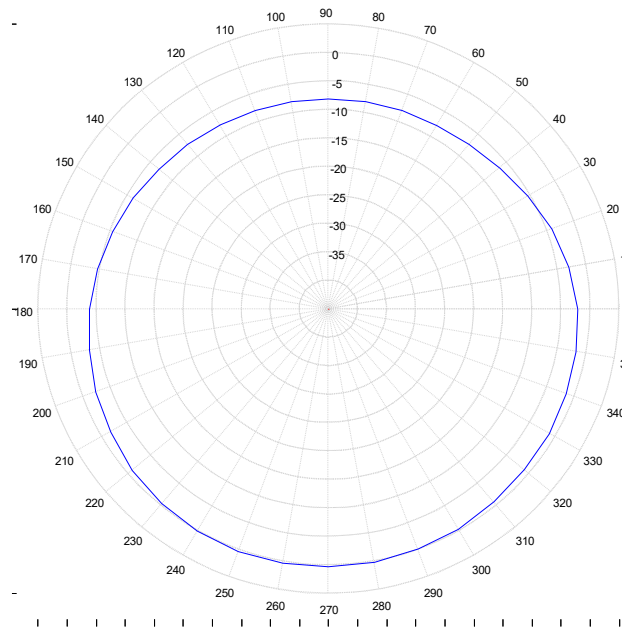

Name: .
Date/Time = 19/10/2023 12:12:48
Plot Scale: 5 dB/Div
Beamwidth: 168.2 Degrees
Frequency: 2606.5 MHz
MAX dB= 0.3588 @ 260 Deg.
MIN dB= -8.138 @ 90 Deg.
dB Min/Max Delta = 8.4977 dB

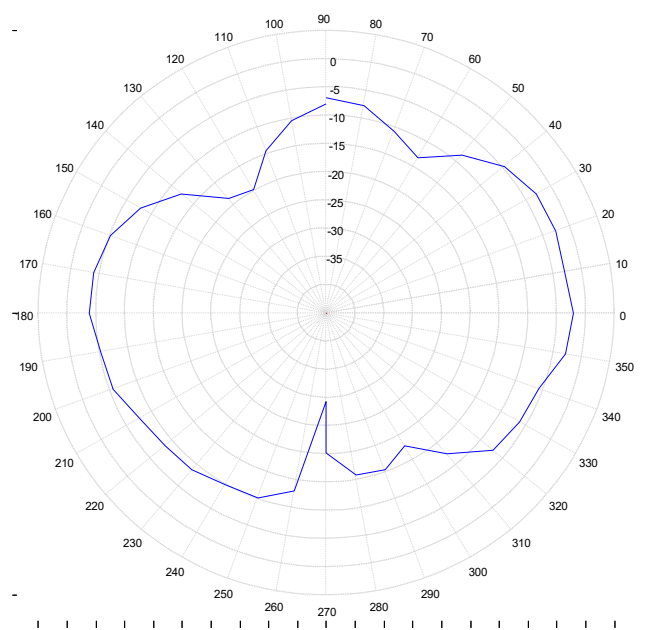

Name: .
Date/Time = 19/10/2023 12:13:35
Plot Scale: 5 dB/Div
Beamwidth: 59.12 Degrees
Frequency: 2606.5 MHz
MAX dB= -2.190 @ -0 Deg.
MIN dB= -29.27 @ -90 Deg.
dB Min/Max Delta = 27.082 dB

AZIMUTH @ 0°ELEVATION AND ELEVATION @ 0° AZIMUTH - 2600MHZ

Product: MARCO POLO LTE

Product Order Code:

BM-02029

CAD Data

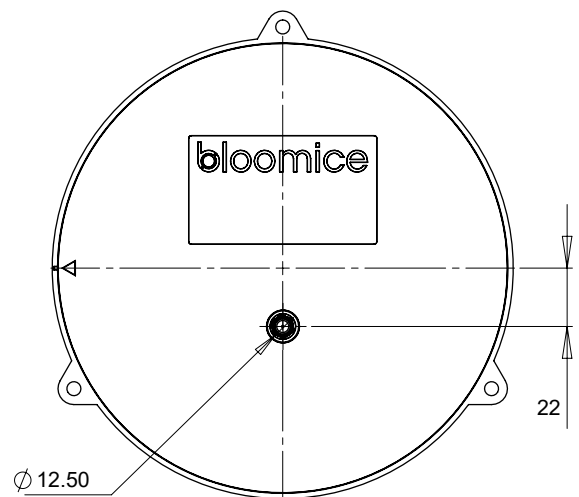
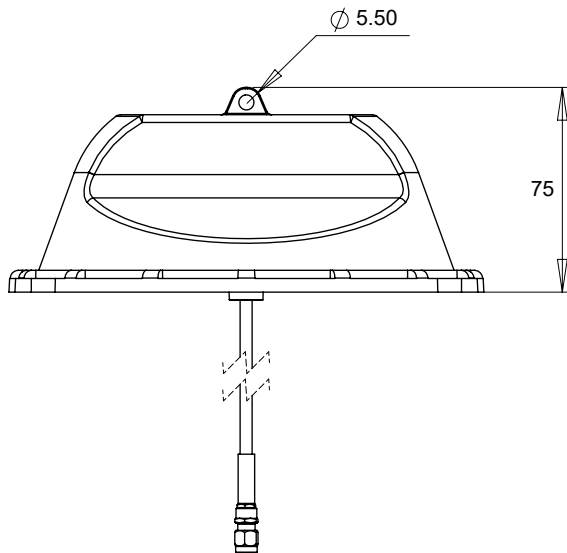
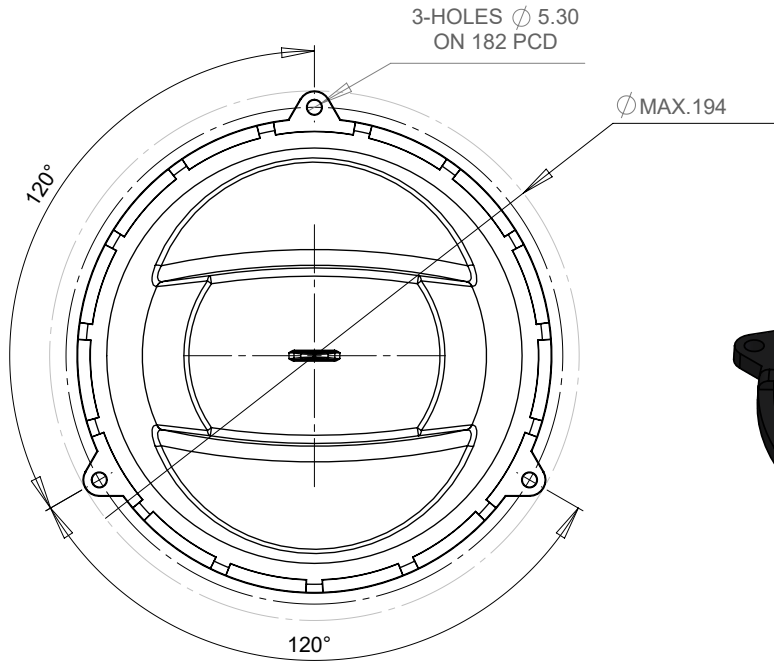

Cable type LL100 length to customer specification

Dimensions in Millimetres